

MH500CP

PRODUCT FEATURE SUMMARY

DATE: 24.04.2024

Username: Evelin Badic

MODEL TYPE: MH500CP

CNSORDERNO (order number)	MH500CP
DC (Displacement code)	500: 502,4 cm ³ /rev [30.7 in /rev]
SE (Shaft Extensions)	C:ø32 straight, Parallel key A10x8x45 DIN 6885
SSV (Shaft Seal Version)	omit: Low pressure seal (integrated check valves)
DP (Drain Port)	omit:with drain port
P (Ports)	omit: BSPP (ISO 228)
SFMS (Special Features measure speed)	omit: no special features
SFGWS (Special Features of gear wheel set)	omit: no special features
SFDR (Special Features – Direction of rotation)	omit: Standard
OP (Option (Paint))	P: Paint
INFO (Info)	PDF catalog
L (mm)	211
L1 (mm)	69.4

DATA SHEET

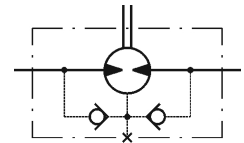

Type		
Displacement, cm³/rev [in³/rev]		502,4 [30.7]
Max. Speed, [RPM]	cont.	150
	Int.*	180
Max. Torque, daNm [lb-in]	cont.	82 [7257]
	Int.*	104 [9204]
Max. Output, kW [HP]	cont.	11 [14.7]
	Int.*	14 [18.7]
Max. Pressure Drop, bar [PSI]	cont.	125 [1810]
	Int.*	160 [2320]
Max. Oil Flow, [RPM]	cont.	75 [19.81]
	Int.*	90 [23.78]

Type		
Max. Inlet Pressure, bar [PSI]	cont.	200 [2900]
	Int.*	225 [3260]
	peak**	250 [3626]
Max. Return Pressure with Drain Line bar [PSI]	cont.	72 [6370]
	Int.*	88 [7788]
	peak**	
Pressure with Unloaded Shaft, bar [PSI]		5 [72]
Min Starting Torque, daNm [lb-in]	at max. press. drop cont.	-
	at max. press. drop Int.*	-
Min. Speed***, [RPM]		5
Weight, kg [lb]		13 [28.7]

* Intermittent operation: the permissible values may occur for max. 10% of every minute.

** Peak load: the permissible values may occur for max. 1% of every minute.

*** For speeds lower than given, consult factory or your regional manager.

- Intermittent speed and intermittent pressure drop must not occur simultaneously.
- Recommended filtration is per ISO cleanliness code 20/16. A nominal filtration of 25 micron or better.
- Recommend using a premium quality, anti-wear type mineral based hydraulic oil HLP(DIN51524) or HM (ISO 6743/4). If using synthetic fluids consult the factory for alternative seal materials.
- Recommended minimum oil viscosity 13 mm²/s [70 SUS] at 50°C [122°F].
- Recommended maximum system operating temperature is 82°C [180°F].
- To assure optimum motor life fill with fluid prior to loading and run at moderate load and speed for 10-15 minutes.

MH500CP

3d generated view

To see model in 3D you should use Acrobat Reader with enable 3D view

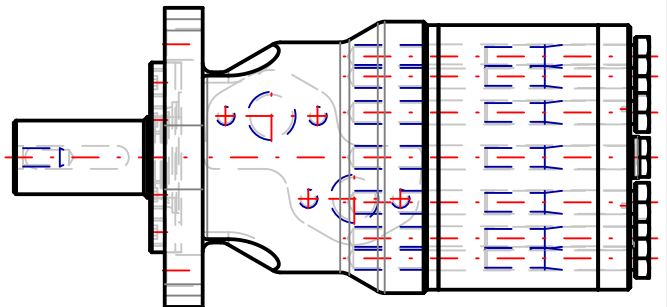
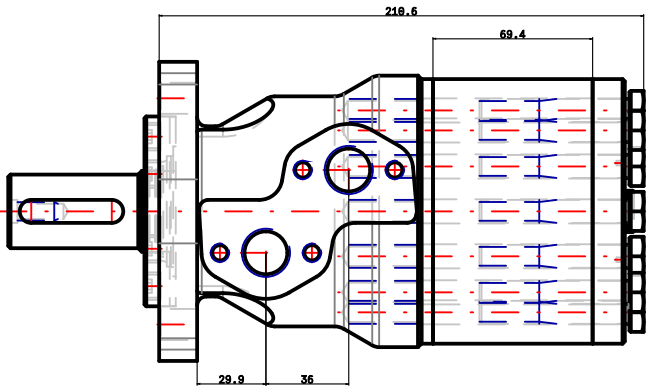
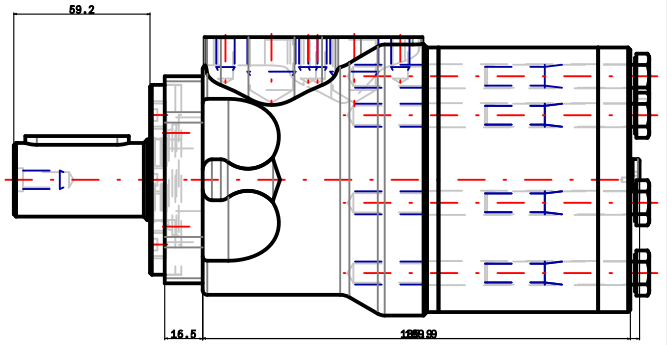
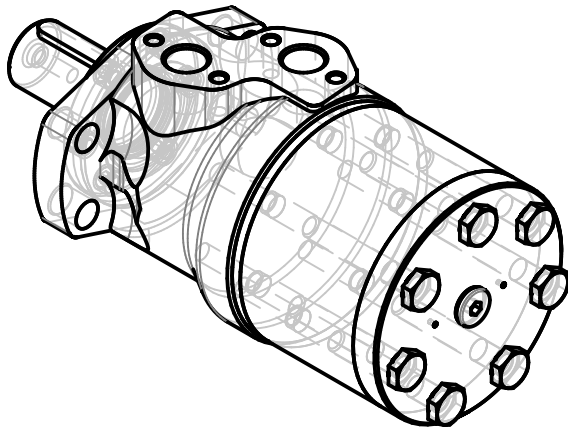

NOTE: Shown dimensions are in nominal, for maximal values see table.

NOTE: For additional dimensions and information about flange , shaft , endcover , etc. see next page.

L max	LS max
211	

Confidential property of M+S Hydraulic, Bulgaria. Please note that this drawing is automatically generated based on the selection. In case of possible changes or revisions in the drawing specifications, the selection process should be repeat. M+S is not responsible for any possible errors on the drawings.



MH500CP

Design: M+S

Check:

Scale	Sheet	Rev.	Weight
Date 24.04.2024			13 [28.7]

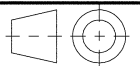

Standard Rotation
Viewed from Shaft End

Port A Pressurized - CW
Port B Pressurized - CCW

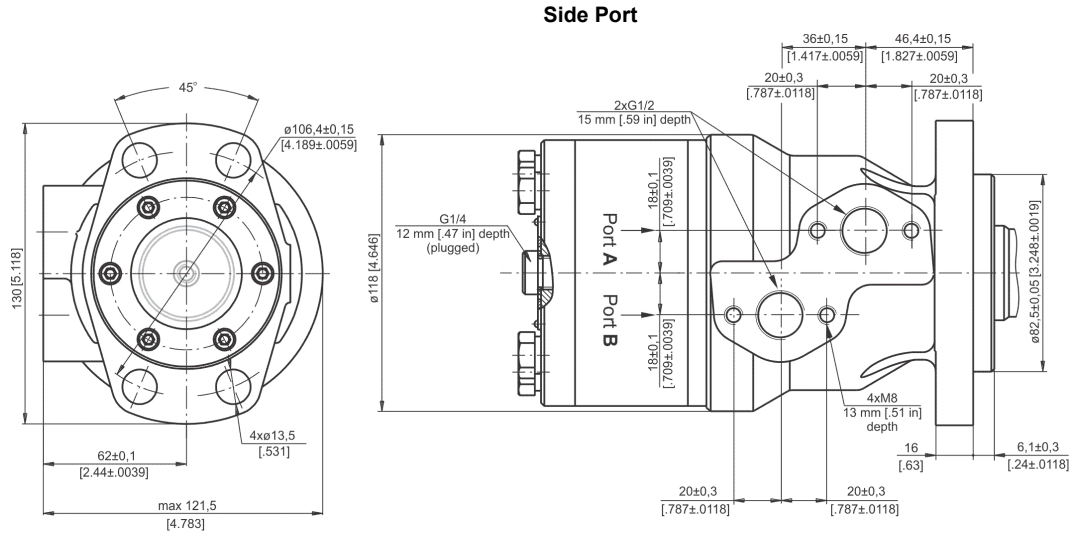

C: $\varnothing 32$ straight, Parallel key A10x8x45 DIN 6885

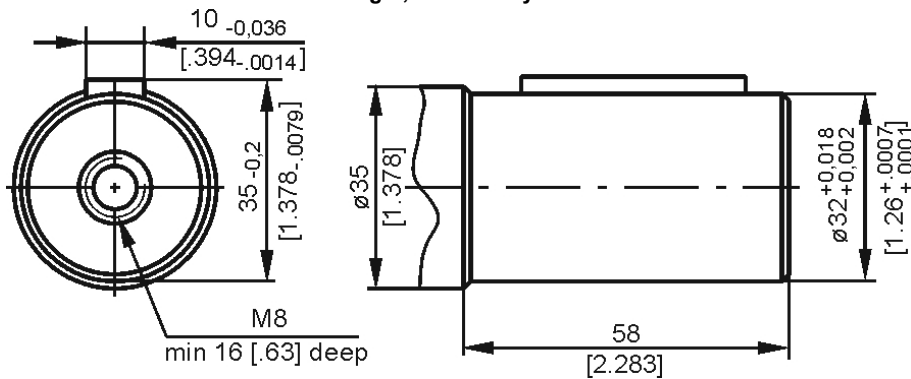

Confidential property of M+S Hydraulic, Bulgaria. Please note that this drawing is automatically generated based on the selection. In case of possible changes or revisions in the drawing specifications, the selection process should be repeat. M+S is not responsible for any possible errors on the drawings.



MH500CP

Design: M+S Check:

Scale	Sheet	Rev.	Weight
Date 24.04.2024			13 [28.7]

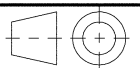

MH500CP

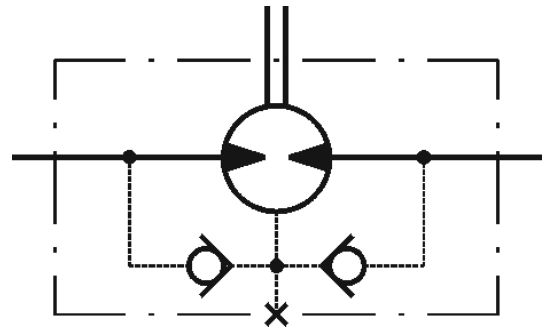

Hydraulic scheme with standard shaft seal and with drain connection

FUNCTION DIAGRAMS

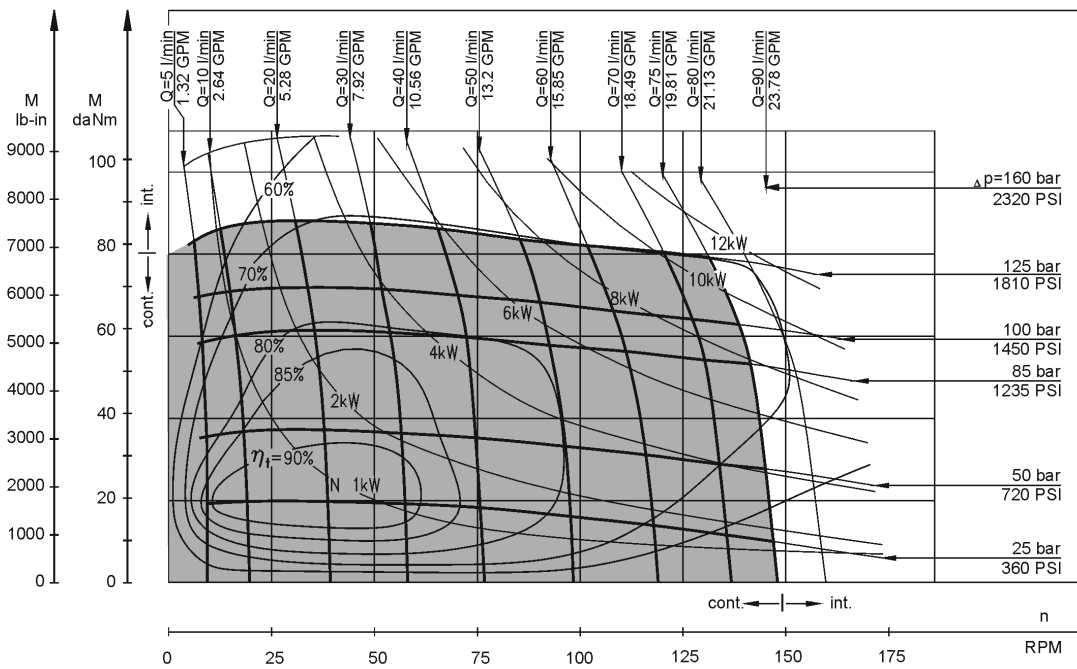

The function diagrams data is for average performance of randomly selected motors at back pressure 5±10 bar [72.5±145 PSI] and oil with viscosity of 32 mm²/s [150 SUS] at 50°C [122°F].

MH500CP

DATA SHEET

Pressure Losses

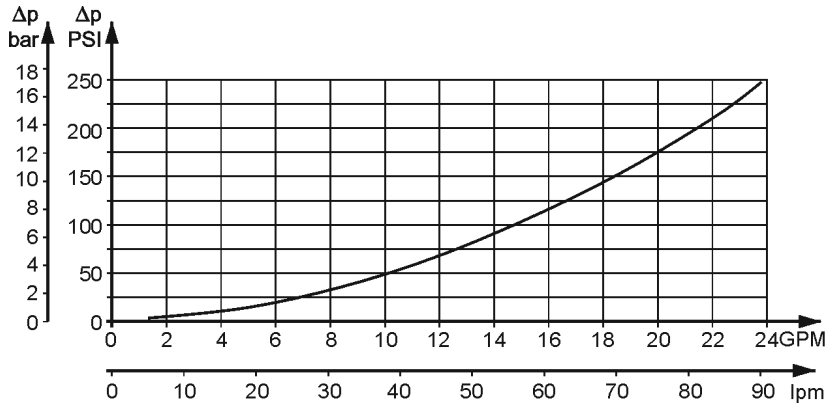

Oil flow in drain line

Pressure drop bar [PSI]	Viscosity mm ² /s [SUS]	Oil flow in drain line lpm [GPM]
100 [1450]	20 [98]	2,5 [.660]
	35 [164]	1,8 [.476]
140 [2030]	20 [98]	3,5 [.925]
	35 [164]	2,8 [.740]

MAX. PERMISSIBLE SHAFT SEAL PRESSURE

Max. return pressure without drain line or max. pressure in the drain line

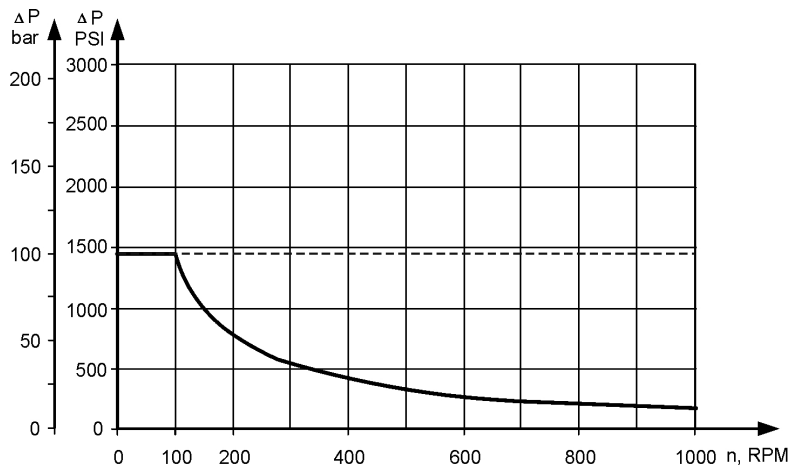

Black Curve shows continuous operations.
Dashed Curve shows intermittent operations.

PERMISSIBLE SHAFT LOADS

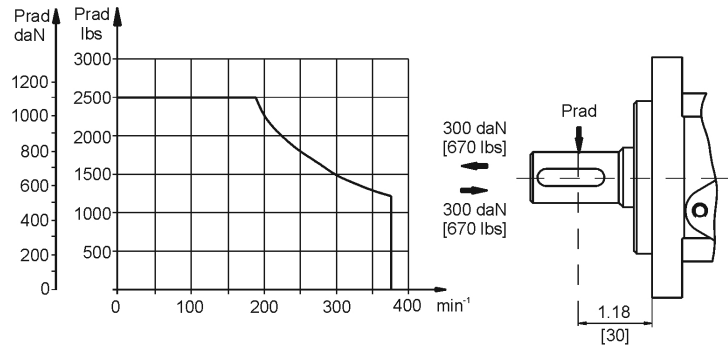

The permissible radial shaft load depends on the speed RPM and distance from the point of load to the mounting flange.